

# DIRECTIONAL COUPLERS

- Octave Band and Broadband
- SMA Connectors
- Meets MIL-E-5400 Class 3 or equivalent
- Screenable to MIL-C-15370 or equivalent



Part Number*	Frequency (GHz)	Coupling (dB)	Flatness <sup>1</sup> (dB)	VSWR Max.		Insertion Loss <sup>2</sup> Max. (dB)	Directivity (dB)	Power Handling	
				Primary	Secondary			Average (W)	Peak (kW)
C0518-10	0.5-18	10 ± 1	±0.8	1.40:1	1.40:1	1.2	20 (0.5-12.4 GHz) 15 (12.4-18 GHz)	5	1.5
C752-6	1-2	6 ± 1	±0.6	1.15:1	1.15:1	0.2	25	2	3.0
C752-10	1-2	10 ± 1	±0.75	1.15:1	1.10:1	0.2	25	5	3.0
C752-20	1-2	20 ± 1	±0.75	1.15:1	1.10:1	0.2	25	50	3.0
C218-6	2-18	6 ± 1	±0.5	1.35:1	1.45:1	1.0	20 (2-12.4 GHz) 17 (12.4-18 GHz)	2	1.5
C218-10	2-18	10 ± 1	±0.5	1.35:1	1.45:1	0.8	20 (2-12.4 GHz) 17 (12.4-18 GHz)	5	1.5
C218-20	2-18	20 ± 1	±0.4	1.35:1	1.45:1	0.6	20 (2-12.4 GHz) 17 (12.4-18 GHz)	25	1.5
C756-6	12-18	6 ± 1	±0.5	1.35:1	1.40:1	0.8	15	2	2.0

<sup>1</sup> Flatness specifies the maximum coupling variation within the coupling range.

<sup>2</sup> Loss is the actual dissipated and reflected loss. It does NOT include coupling loss.

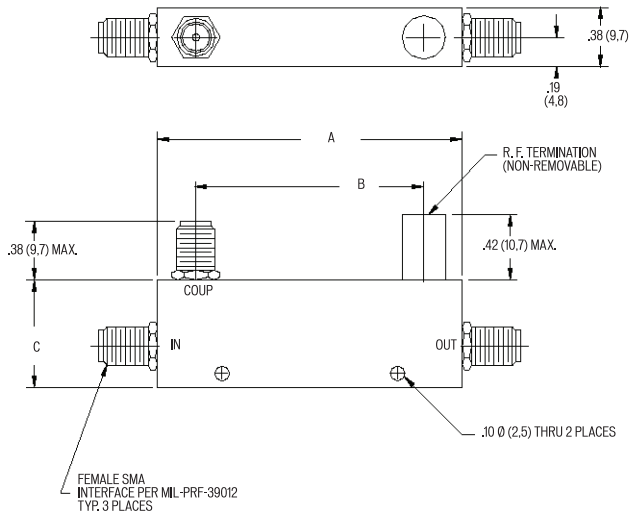

Part Number*	Dim. A	Dim. B	Dim. C
C0518-10	4.50 (114,30)	4.00 (101,6)	.70 (17,8)
C752-6/10/20	1.78 (45,2)	1.28 (32,5)	.50 (12,7)
C218-6/10/20	1.98 (50,3)	1.48 (37,6)	.70 (17,8)
C756-6	1.00 (25,4)	.50 (12,7)	.50 (12,7)

All dimensions shown in decimal inches (mm). Specifications subject to change without notice.  
For mounting instructions, additional specifications or other products, visit us online or contact the factory.

## 3 dB 90° Crossover Hybrid Couplers

- SMA connectors
- Unbalance: 1 dB Max.<sup>2</sup> Except 2375-7 and -9 at 2.2 dB Max.
- Meets MIL-E-5400 Class 3 or equivalent
- Screenable to MIL-P-23971 or equivalent



Part Number*	Frequency (GHz)	Insertion Loss <sup>1</sup> Max. (dB)	VSWR Max.	Isolation Min. (dB)	Deviation from Phase Quadrature Typ. (°)	Power Handling		Outline
						Average @1GHz (W)	Peak (kW)	
DC751	0.5-1	0.15	1.1:1	25	±1.5	100	3.0	A
2375-1	0.5-2	0.4	1.15:1	24	±2.0	50	1.5	A
DC752	1-2	0.2	1.1:1	25	±1.5	100	3.0	A
2375-2	1-4	0.4	1.25:1	22	±3.0	50	1.5	A
DC752E	1.3-2.6	0.2	1.15:1	25	±2.0	100	3.0	A
DC754	4-8	0.3	1.25:1	20	±2.0	100	3.0	A
2375-4	4-12.4	0.4	1.35:1	18	±5.0	50	1.5	A
2375-7	1-18	0.8 (1-6 GHz) 1.2 (6-12 GHz) 1.6 (12-18 GHz)	1.50:1	15	±10.0	50	1.5	B
2375-9	2-18	0.6 (2-6 GHz) 1.0 (6-12.4 GHz) 1.25 (12.4-18 GHz)	1.45:1	20 16	±8.0	50	1.5	B

<sup>1</sup> Maximum loss is the actual dissipative loss and reflective loss due to VSWR. It does NOT include coupling loss.

<sup>2</sup> Unbalance is measured as the difference between the coupled and mainline output ports from the mean coupling at each frequency.

Part Number*	Dim. A	Dim. B
DC751	3.27 (83,1)	3.13 (79,5)
DC752	1.84 (46,7)	1.70 (43,2)
DC752E	1.57 (39,9)	1.43 (36,3)
DC754	1.06 (26,9)	.92 (23,4)
2375-1	5.36 (136,1)	5.22 (132,6)
2375-2	2.97 (75,4)	2.83 (71,9)
2375-4	1.31 (33,3)	1.17 (29,7)

Part Number*	Dim. A	Dim. B
2375-7	2.53 (64,3)	2.03 (51,6)
2375-9	2.03 (51,6)	1.53 (38,9)

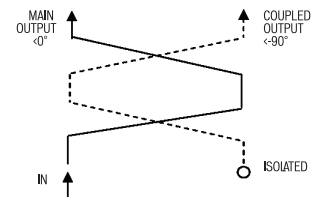
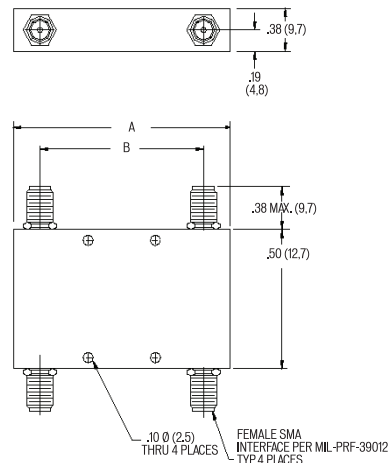
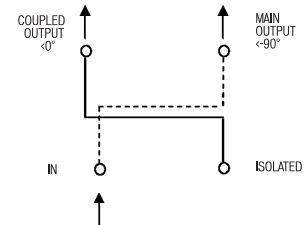
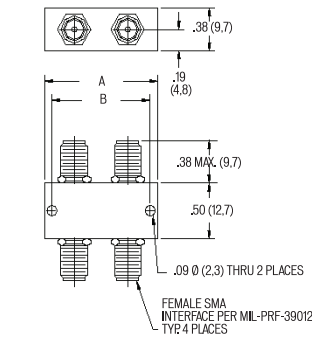

All dimensions shown in decimal inches (mm). Specifications subject to change without notice.  
For mounting instructions, additional specifications or other products, visit us online or contact the factory.

## 3 dB TEMline™ Hybrid Couplers

- Type N connectors
- Average power rating 1000 watts, Normalized at 1 GHz
- Meets MIL-E-5400 Class 3 or equivalent
- Screenable to MIL-P-23971 or equivalent



Part Number*	Frequency Range (GHz)	Insertion Loss <sup>1</sup> Max. (dB)	Unbalance <sup>2</sup> Max. (dB)	VSWR Max.	Isolation Min. (dB)	Deviation from Phase Quadrature Typ. (°)
750	0.25-0.5	0.1	1	1.20:1	20	±3
751	0.5-1	0.1	1	1.25:1	20	±3
752	1-2	0.1	1	1.25:1	20	±3
753	2-4	0.1	1	1.25:1	20	±3

<sup>1</sup> Maximum loss is the actual dissipative loss and reflective loss due to VSWR. It does NOT include coupling loss.

<sup>2</sup> Unbalance is measured as the difference between the coupled and mainline output ports from the mean coupling at each frequency.

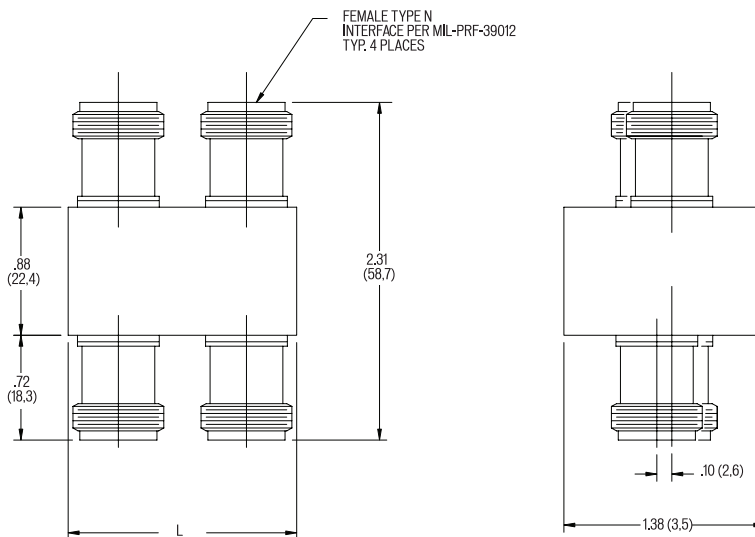

Part Number*	Dim. L
750	6.31 (160,3)
751	3.47 (88,1)
752	2.09 (53,1)
753	1.50 (38,1)

All dimensions shown in decimal inches (mm). Specifications subject to change without notice.  
For mounting instructions, additional specifications or other products, visit us online or contact the factory.

## Wireline® 3dB Quadrature Hybrids

- Drop-in (consult factory for cut & trimmed and connectorized options)
- Bendable / formable
- Low loss, low cost
- Aerospace and commercial heritage
- RoHS compliant (tin-plated and bare finishes only)

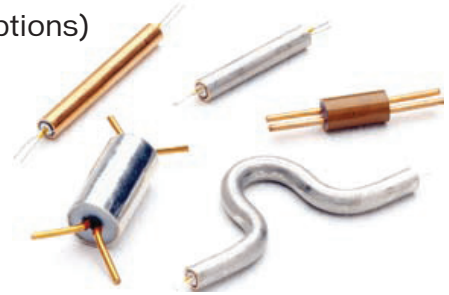

Electrical Specification	Part Number (see Part Number Key)	BHC*1 HC*1	BJC*1 JC*1	BHC*2 HC*2	BJC*2 JC*2
	Bandwidth Optimization		Narrow	Narrow	Octave
Coupling, Coupled Path (dB)		3.00 ±0.25	3.00 ±0.25	2.65 ±0.25	2.65 ±0.25
Unbalanced, Max. (dB), Coupled Path to Main Line		0.5	0.5	1.3	1.3
Insertion Loss Max. (dB)		0.3	0.3	0.3	0.3
Isolation, Min. (dB)		20	20	20	20
VSWR, Max.		1.2:1	1.2:1	1.2:1	1.2:1
Power, Average (W)		100	200	100	200
Power, Peak (kW)		2	2	2	2
Phase Quadrature Error, Max. (°)		±1	±1	±1	±1
Dielectric Breakdown, Min. (V RMS)		500	500	500	500

\* Shield finish code - see Part Number Key.

Electrical specifications summarized in the table above are determined by measurements at 300 MHz in a matched 50 ohm system and are independent of physical length and frequency with the exception of power. At jacket temperatures above 55°C, the power should be derated linearly to 50% at 105°C and to 0 at 155°C.

### Mechanical Specification

Weight ounces (grams) per inch/mm	0.19 (.55)	0.40 (1.14)	0.19 (.55)	0.40 (1.14)
Bendable / Formable	Yes	Yes	Yes	Yes
Center Line Bend radius, Min.	.15 (3,8)	.30 (7,6)	.15 (3,8)	.30 (7,6)
Dimension "A" Inner Jacket Diameter	.086 (2,2)	.125 (3,2)	.086 (2,2)	.125 (3,2)
Dimension "B" Outer Shield Diameter	.105 (2,7)	.145 (3,7)	.105 (2,7)	.145 (3,7)
Dimension "D" Wire Diameter	.0124 (0,3)	.0201 (0,5)	.0124 (0,3)	.0201 (0,5)

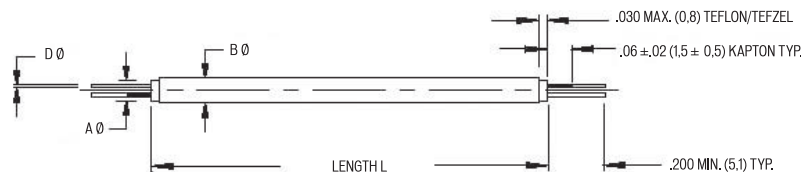

All dimensions shown in decimal inches (mm). Specifications subject to change without notice.  
For mounting instructions, additional specifications or other products, visit us online or contact the factory.

## Wirepac® 3dB Quadrature Hybrids

- Drop-in, surface mount and flanged options
- Ready to install
- High power handling capability
- Low loss, low cost
- Aerospace and commercial heritage

Electrical Specification	Part Number (see Part Number Key)	FA*1 KC*1 LC*1	KC*2 LC*2
	Bandwidth Optimization		Narrow
Coupling, Coupled Path (dB)		3.00 ±0.15	2.70 ±0.15
Unbalanced, Max. (dB), Coupled Path to Main Line		0.3	1.1
Insertion Loss Max. (dB)		0.2	0.2
Isolation, Min. (dB)		30	30
Directivity, Min. (dB)		27	27
VSWR, Max.		1.1:1	1.1:1
Power, Average (W)		500	500
Power, Peak (kW)		2.5	2.5
Phase Quadrature Error, Max. (°)		±1	±1
Dielectric Breakdown, Min. (V RMS)		1000	1000

\* Shield finish code – see Part Number Key.

Electrical specifications summarized in the table above are determined by measurements at 300 MHz in a matched 50 ohm system and are independent of physical length and frequency with the exception of power. At jacket temperatures above 55°C, the power should be derated linearly to 50% at 105°C and to 0 at 155°C.

Mechanical Specification	FA*1	KC*1, LC*1 KC*2, LC*2
	Weight ounces (grams) per inch/mm	0.15 (4,3)

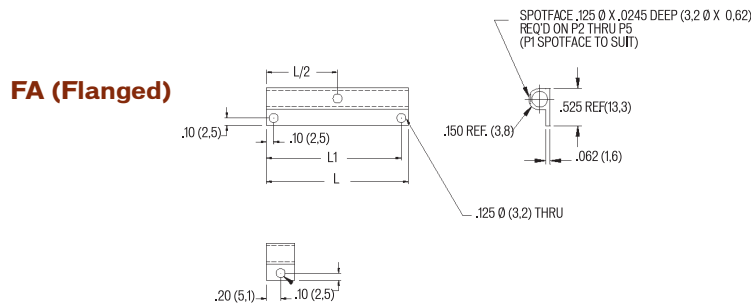

### KC (Round), Crossover & Non-Crossover

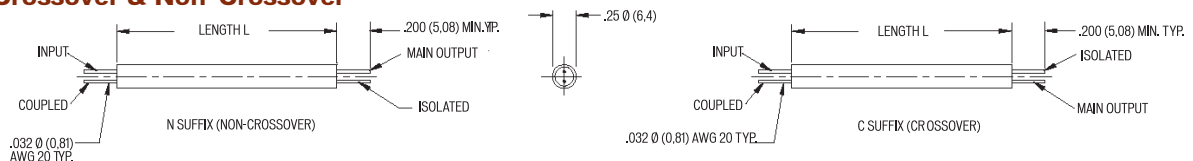

### LC (Square), Crossover & Non-Crossover

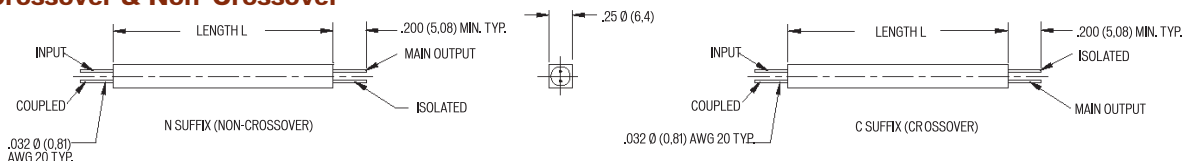

All dimensions shown in decimal inches (mm). Specifications subject to change without notice.  
For mounting instructions, additional specifications or other products, visit us online or contact the factory.