

DESCRIPTION

- 570 MHz SAW bandpass filter with 17 MHz bandwidth.
- 7 x 5 mm 10-pad LCC package.
- RoHS compliant.

TYPICAL PERFORMANCE

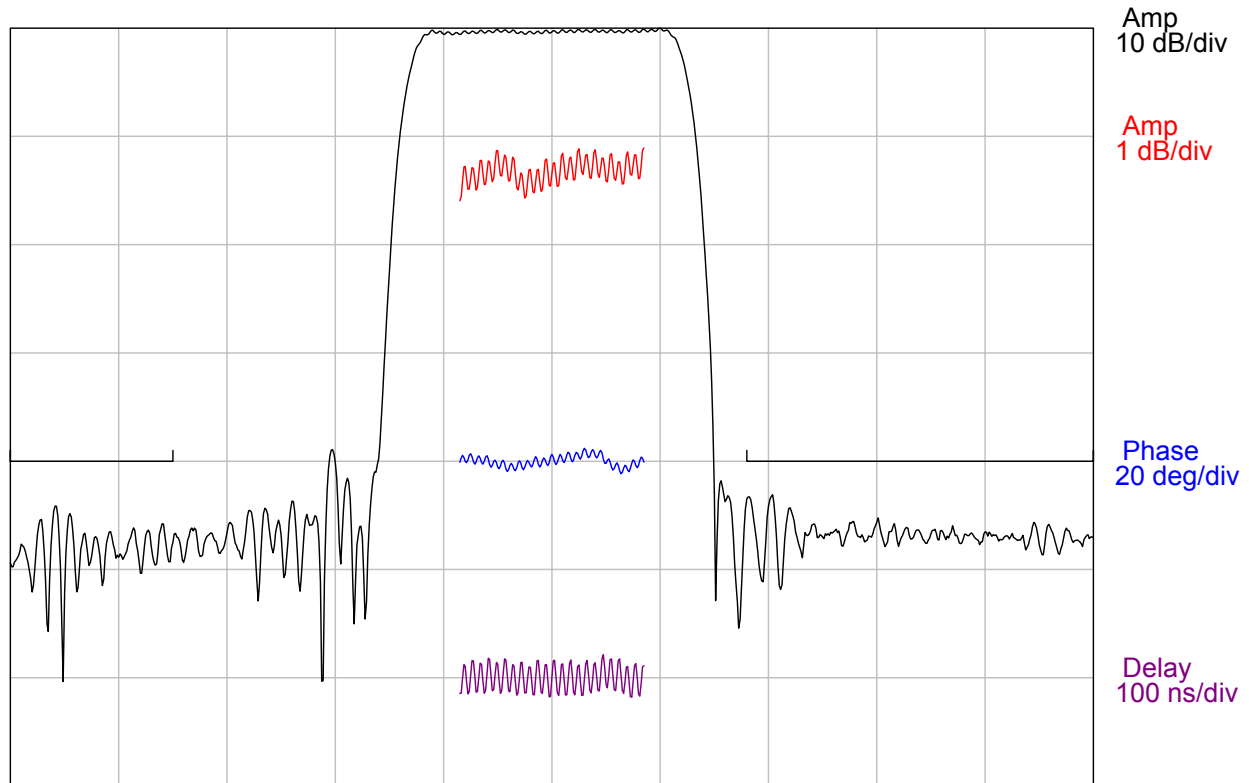

Center = 570 MHz, 10 MHz/div (125 kHz incr)

S11 (520-620 MHz)

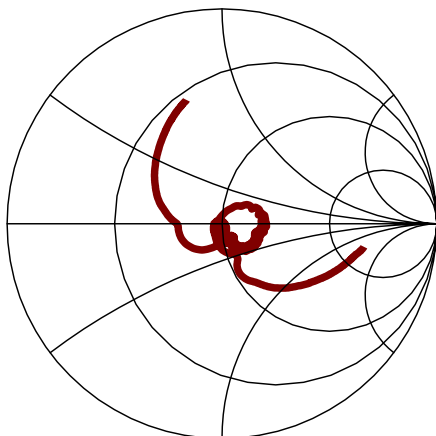

S22 (520-620 MHz)

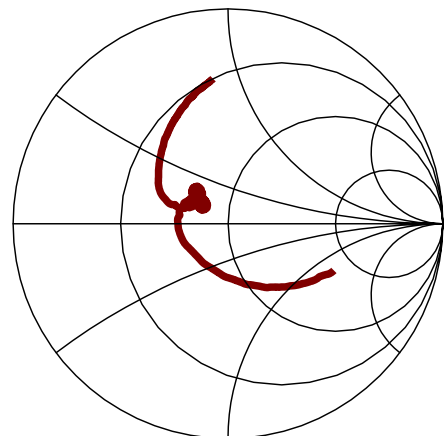

SPECIFICATION

Parameter	Min	Typ	Max	Units
Center Frequency (F_c) ³	-	570	-	MHz
Minimum Insertion Loss	-	18.7	20	dB
Lower 1 dB Frequency ¹	-	557.9	561.5	MHz
Upper 1 dB Frequency ¹	578.5	581.4	-	MHz
1 dB Bandwidth ¹	17	23.4	-	MHz
3 dB Bandwidth ¹	-	24.9	-	MHz
In-band Amplitude Ripple	-	0.5	1	dB p-p
In-band Group Delay Ripple	-	45	80	ns p-p
Relative Attenuation (20 to 535 MHz) ¹	40	43	-	dB
Relative Attenuation (588 to 1000 MHz) ¹	40	43	-	dB
Input Return Loss ($F_c \pm 7.5$ MHz)	-	12	-	dB
Output Return Loss ($F_c \pm 7.5$ MHz)	-	12	-	dB
Temperature Coefficient of Frequency (T_c) ²	-18			ppm/ $^{\circ}$ C
Source/Load Impedance	50			ohms
Ambient Temperature (T_{ref})	25			$^{\circ}$ C

- Notes:
1. All dB levels are referenced to the insertion loss value.
 2. Typical shift of frequency response with temperature is: $\Delta f = (T - T_{ref}) * T_c * F_c$.
 3. Defined as the mean of the lower and upper 3 dB frequency values.

MAXIMUM RATINGS

Parameter	Min	Max	Units
Storage Temperature Range	-40	85	$^{\circ}$ C
Operating Temperature Range	-20	60	$^{\circ}$ C
Input Power Level	-	10	dBm

MATCHING CIRCUIT

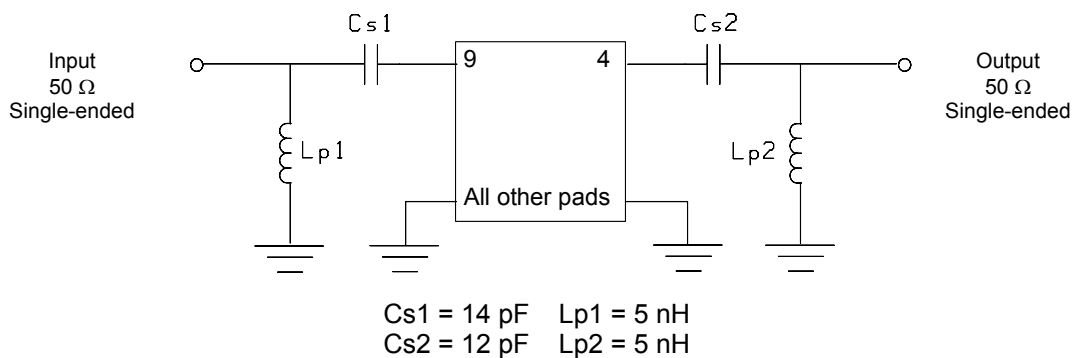

Notes:

- Recommend 2% toleranced components. Typical Inductor Q=40.
- Values shown are for reference only and depend upon board layout.

PACKAGE OUTLINE

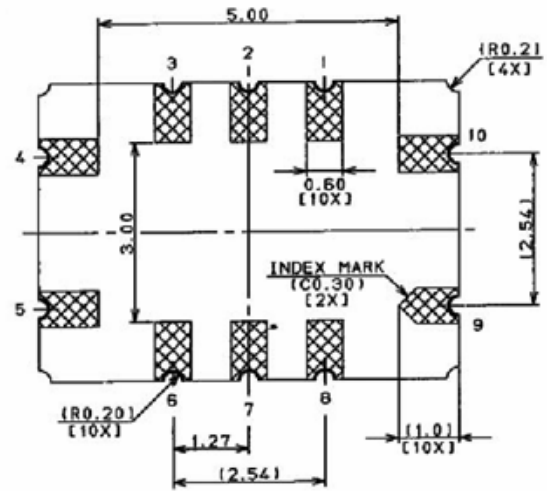
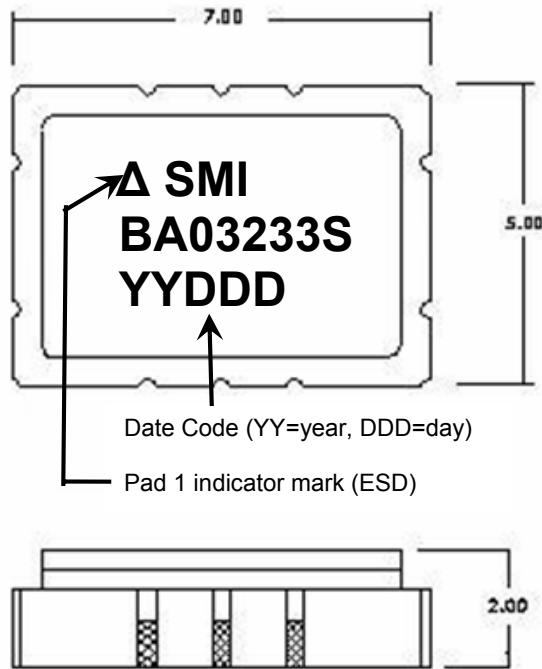

SUGGESTED FOOTPRINT

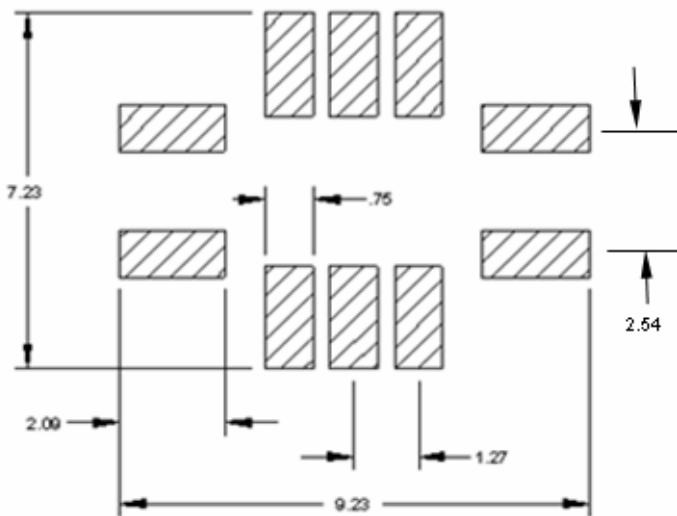

Units: mm

Tolerances are typically ± 0.15 mm except where indicated.

Pad Configuration:

- Input: 9
- Input return: 10
- Output: 4
- Output return: 5
- Ground: All other pads

ISO 9001
 Registered

All specifications are believed to be accurate and reliable. However, Spectrum Microwave reserves the right to make changes without notice.
 © 2010 All rights reserved.